



 Ø6,3x50 mm A1 x 8	 Ø12 mm A2 x 8	 4 mm A3 x 1	 Ø4x30 mm D x 4	 Ø1,6x25 mm F x 32
 Ø5x16 mm L x 8	 M x 4	 682 mm O x 2	 Ø8x30 mm T x 2	 U1 x 2
 U2 x 2				



Box

715x280x16 mm

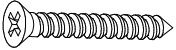

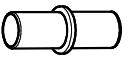
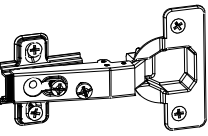
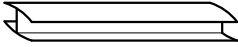
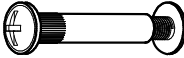
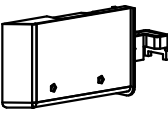
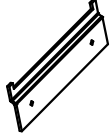
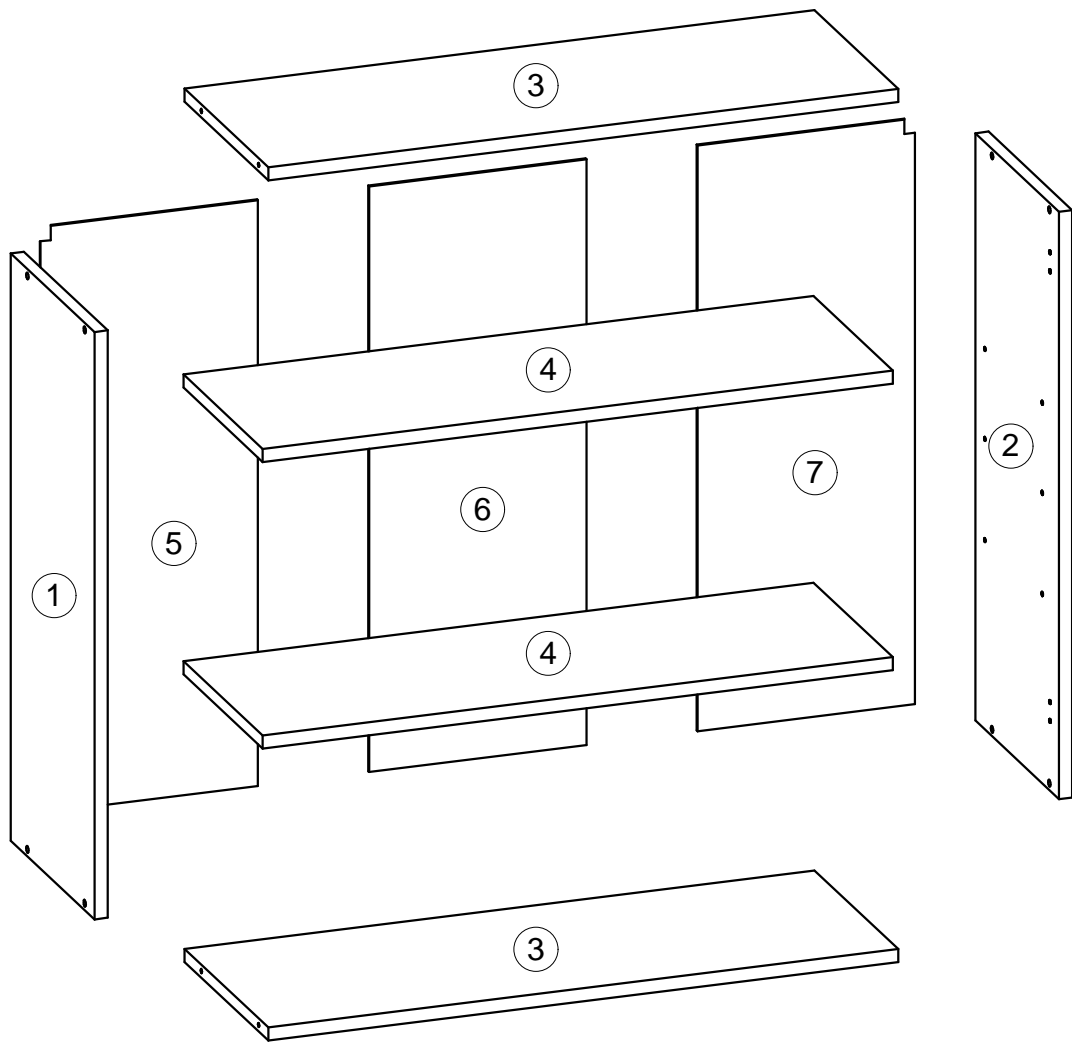
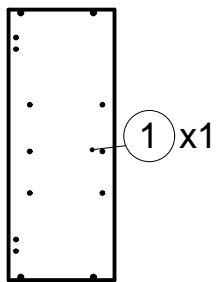
715x280x16 mm

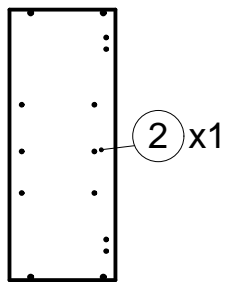

768x280x16 mm

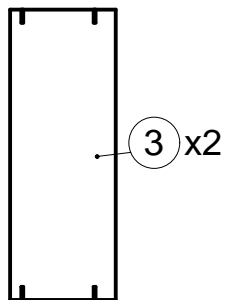

768x260x16 mm

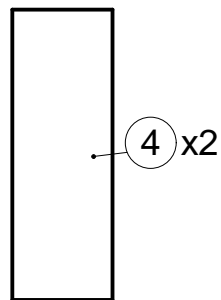

714x265x3 mm

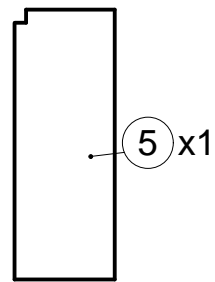

714x265x3 mm

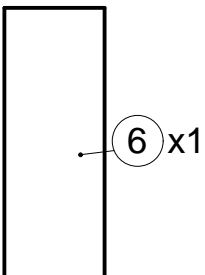

714x265x3 mm

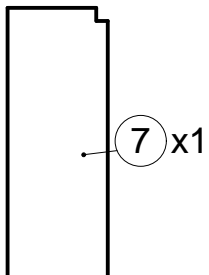

Fittings & Tools

1

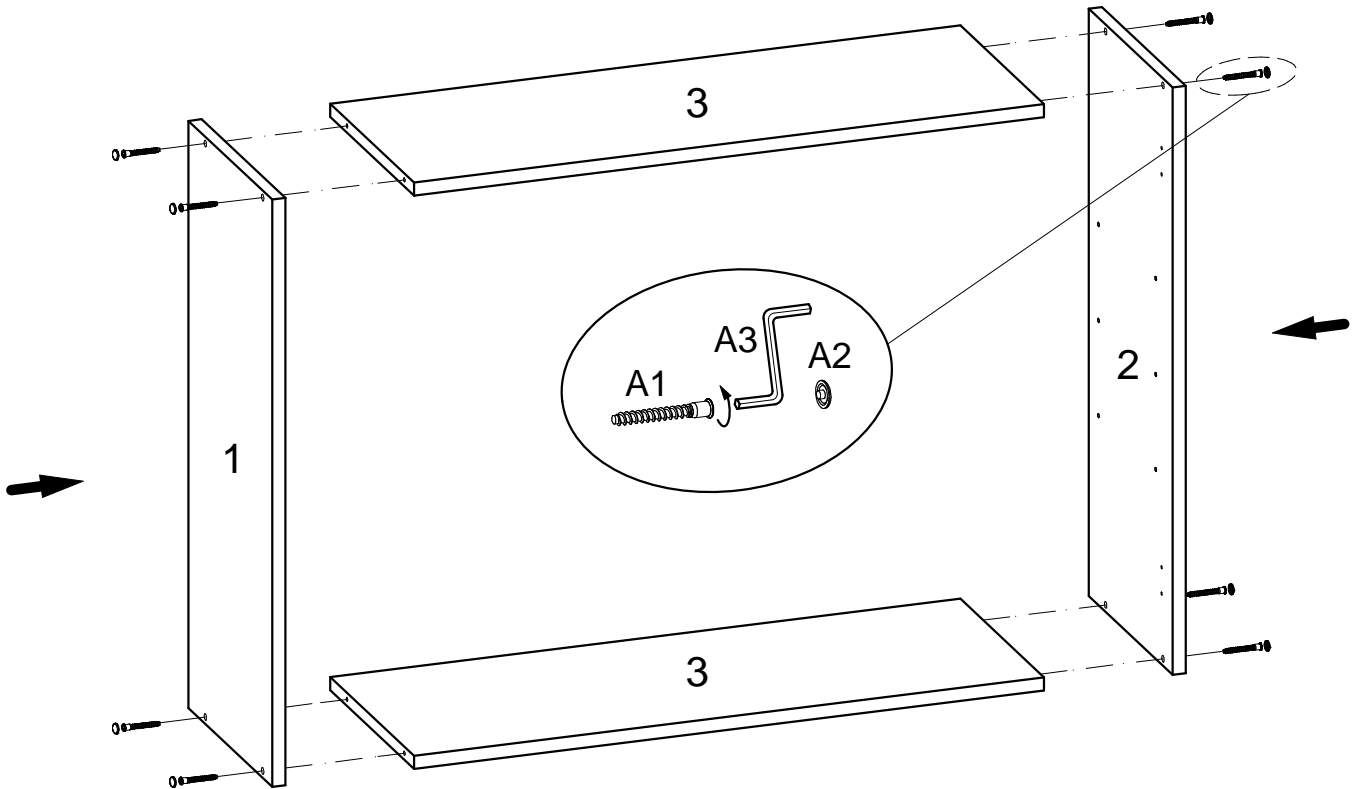
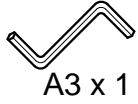
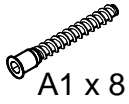

2

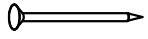

F x 32

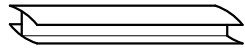

O x 2

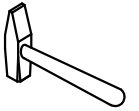

$XX=YY\cong 90^\circ$

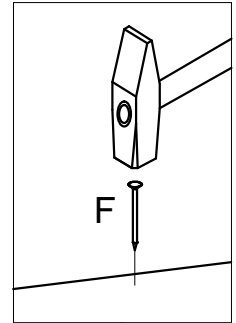
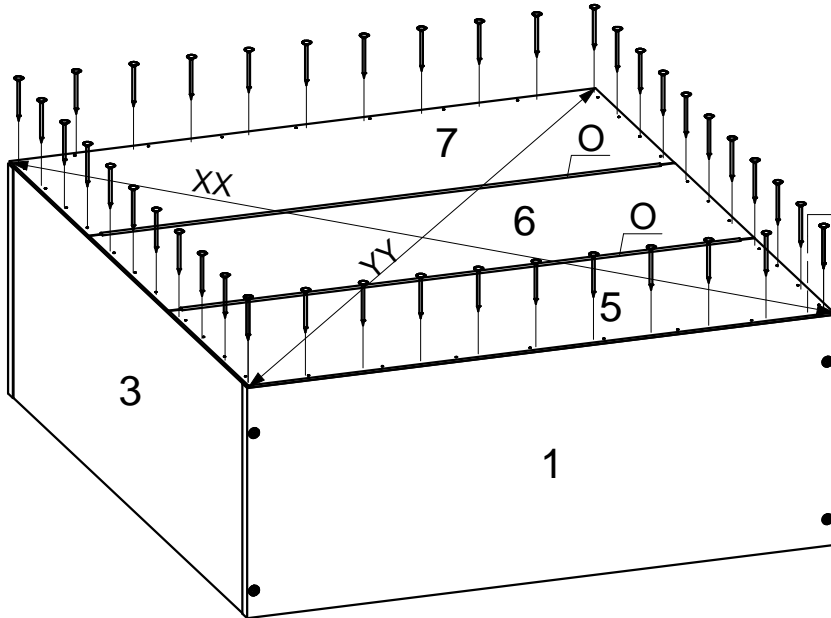

3



L x 8



M.1 x 4

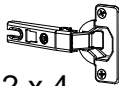

M.2 x 4

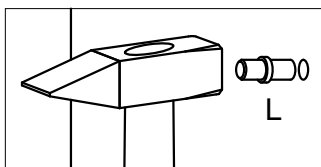
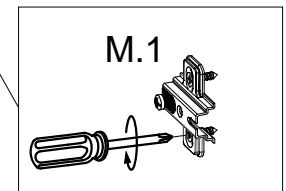
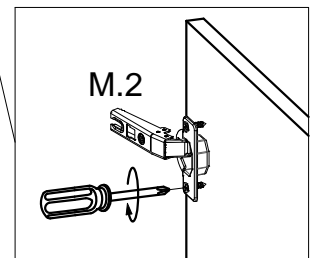
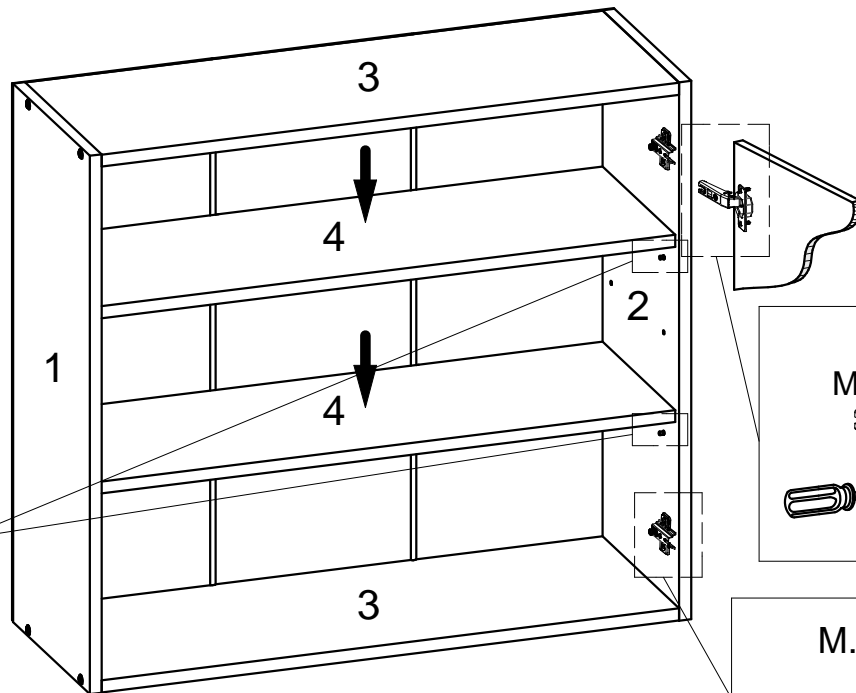
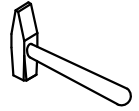
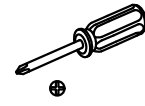



D x 4

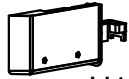

U1 x 2

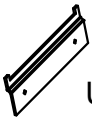
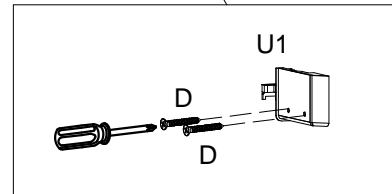
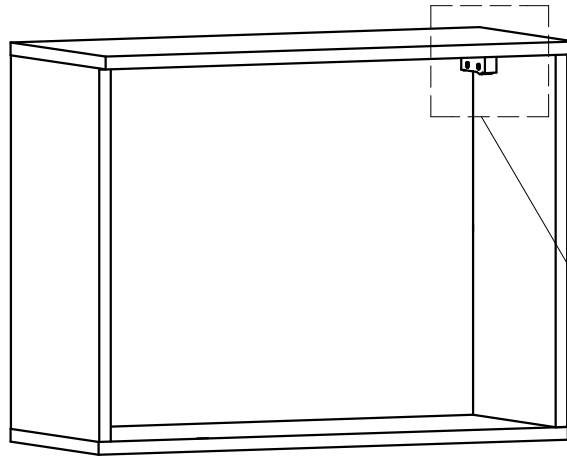
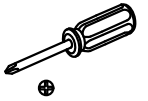

U2 x 2

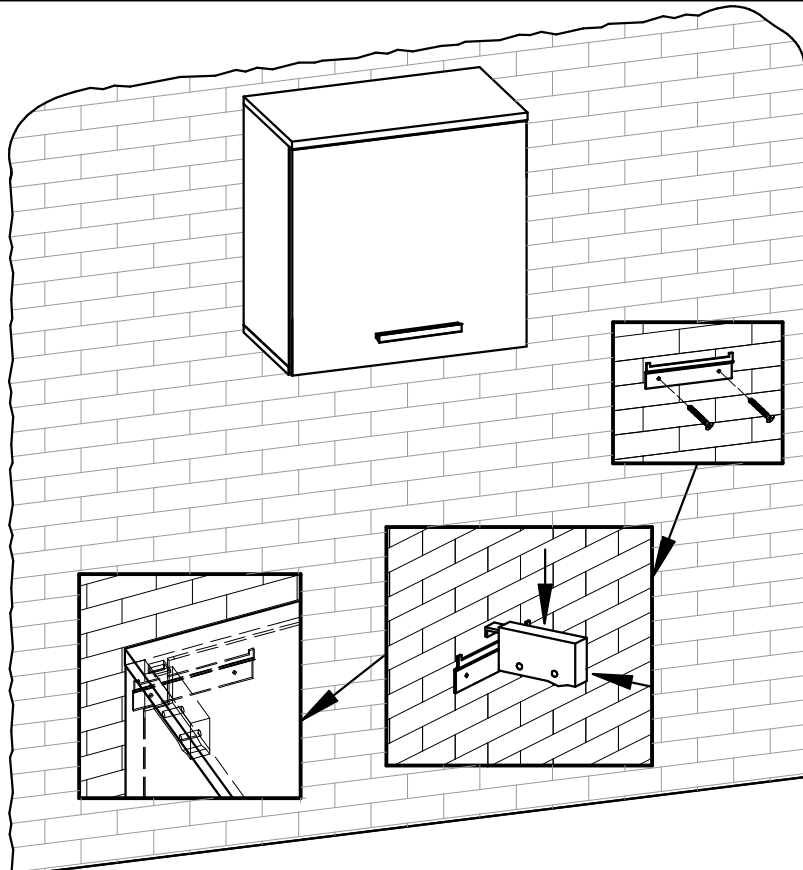



T x 2

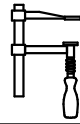

Ø8

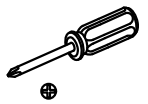
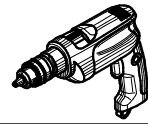

1

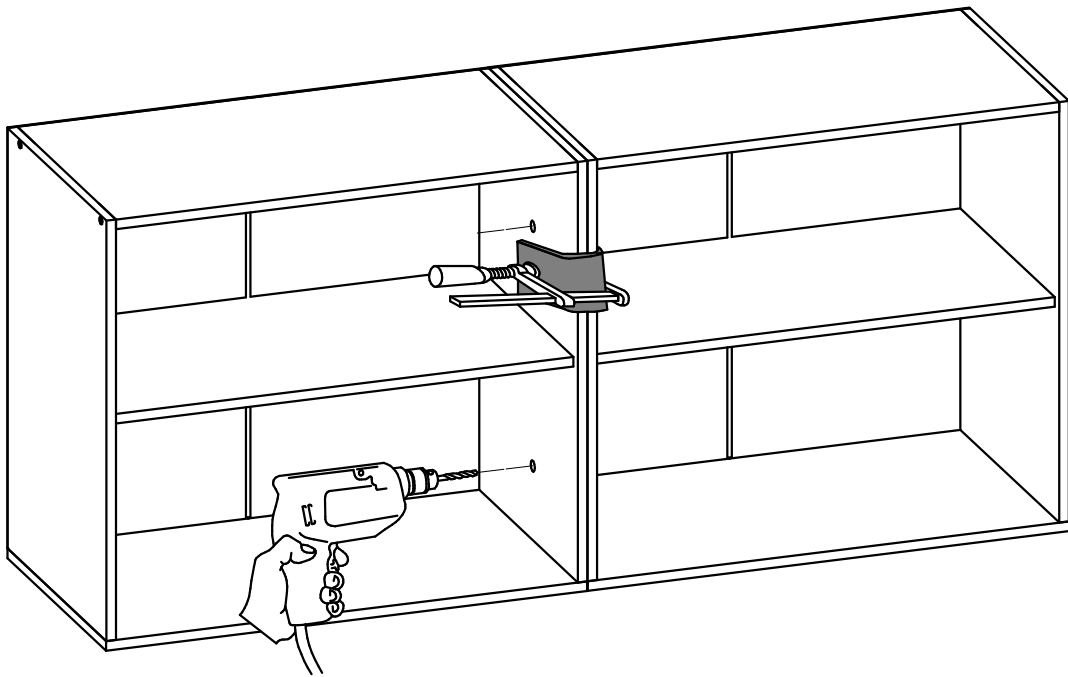

2

